

Efficient Bus Wiring in Expert

1. Introduction

The Bus command is used in Expert to route several wires simultaneously with specified spacing. The Bus command is able to set freely the number of wires that will be routed as well as horizontal and vertical spacing between wires.

When you need to change the space of each Wire object from a narrow (wide) value to a wide(narrow) value, Bus wiring can be made using 45 degree angles since Expert 4.8.10.C.

2. The Bus command options

Pop up the Numeric Input panel of the Bus command (See Figure 1) using [Edit]->[Create Object]->[Bus] or by pressing F9.

The various options of the bus command can be set from the Numeric Input panel.

- Layer: The layer used by the Bus wiring
- Width: The width used by the Wire object
- End: The end style of each Wire object
- Joint: The joint style of each Wire object
- Wires: The number of Wire objects used by the Bus wiring.
- DX: The space in the horizontal direction of each Wire object.
- DY: The space in the vertical direction of each Wire object.
- Align: The alignment of the Bus wiring
- Multipath: When the contact is defined by the technology, it is possible to change the wiring layer
- Same Value of DX/DY: The space of DX/DY is set to the same value by inputting only the DX value when the DX/DY of each Wire object is the same
- Use 45 deg. narrowing: When the space of each wire is changed, bus wiring of 45 degrees is created with a value of the narrow one before and after the change

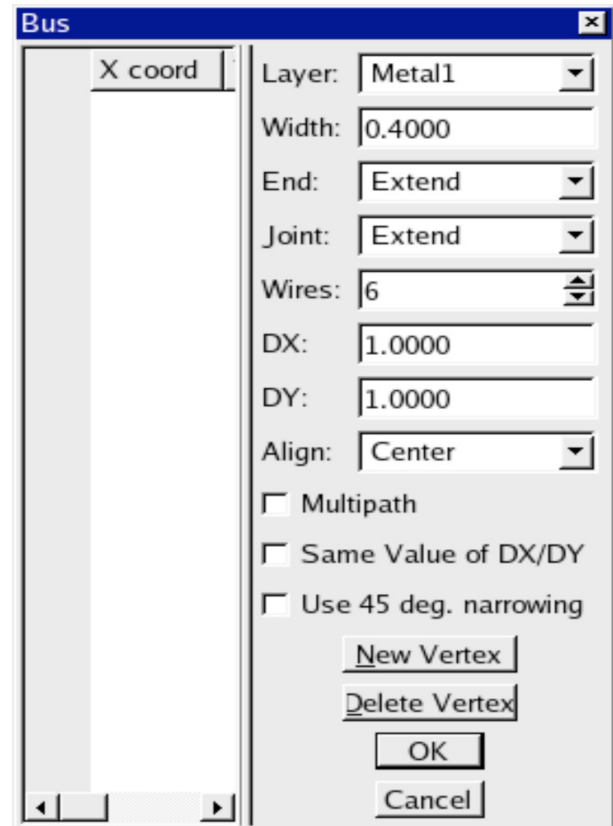

Figure 1. The Numeric Input panel of the Bus command.

3. Creating Bus wiring

- 1) Execute the Bus command.
- 2) Set each parameter with the Numeric Input panel
- 3) Click the starting point and each bend point
- 4) Double-clicked the end point
- 5) The last bend point can be canceled using the Undo command.

4. A Variety of Bus Wirings

A variety of bus wirings can be made by setting each parameter of the angle mode, the snap mode of the mouse cursor, and the Numeric Input panel of the Bus command.

1) Angle Mode

The Bus wiring when the angle mode is set to 90° mode, and the DX/DY is set to the same value, is shown in Figure 2.

The Bus wiring when the angle mode is set to 45° mode, and the DX/DY is set to the same value, is shown in Figure 3.

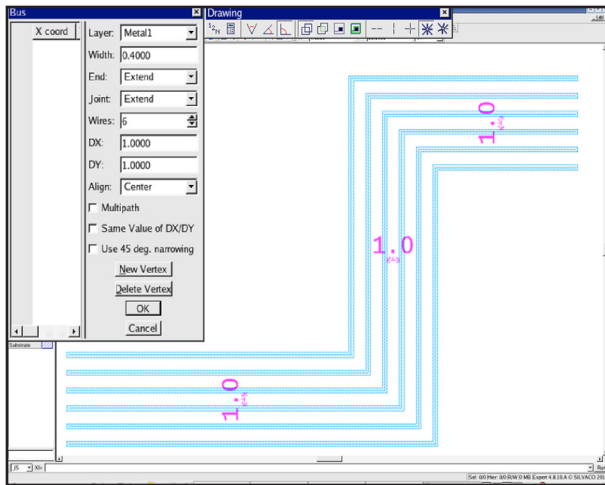

Figure 2. Angle mode=90° mode, DX=DY.

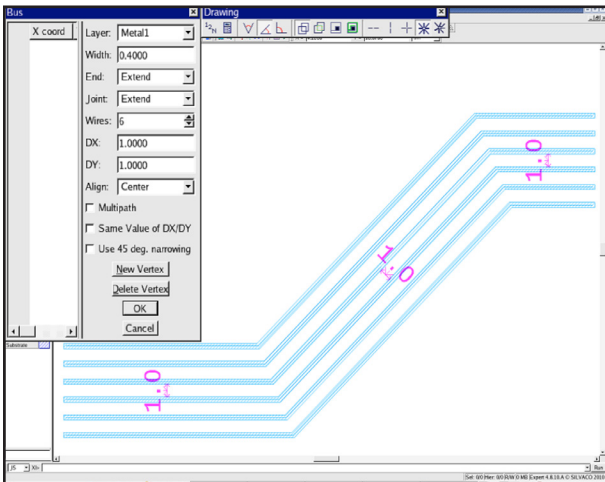

Figure 3. Angle mode=45° mode, DX=DY.

When “Same Value of DX/DY” is selected, the DX/DY value can be set only by inputting the DX value as shown in Figure 4.

The Bus wiring when the angle mode is set to 90° mode, and the DX/DY is set to a different value, is shown in Figure 5.

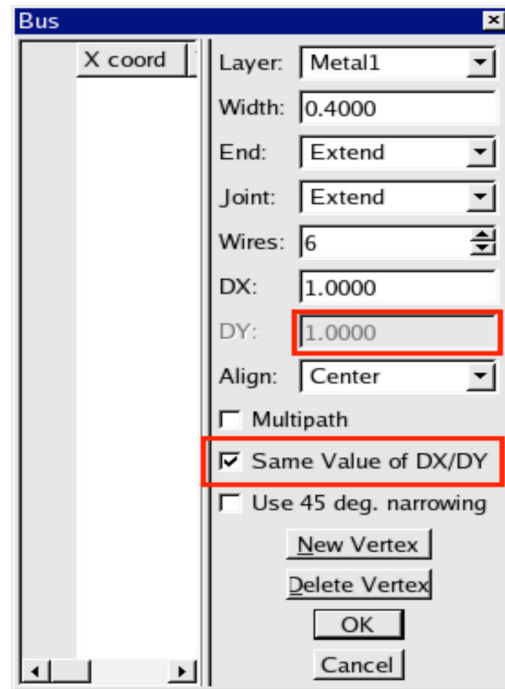

Figure 4. Turn on Same Value of DX/DY.

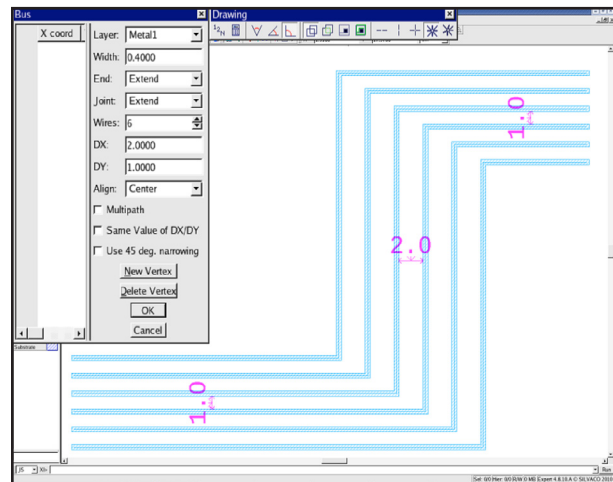

Figure 5. Angle mode=90° mode, DX≠DY.

The Bus wiring when the angle mode is set to 45° mode, and the DX/DY is set to a different value, is shown in Figure 6.

A large value of DX/DY is applied for the wire space in the part made at 45 degrees.

2) Change of DX/DY

The Bus wiring when the value of DX/DY is changed is shown in Figure 7.

3) Use 45 deg. narrowing

The Bus wiring when “Use 45 deg. narrowing” is selected, and the value of DX is changed from 1.0 to 3.0, is shown in Figure 8.

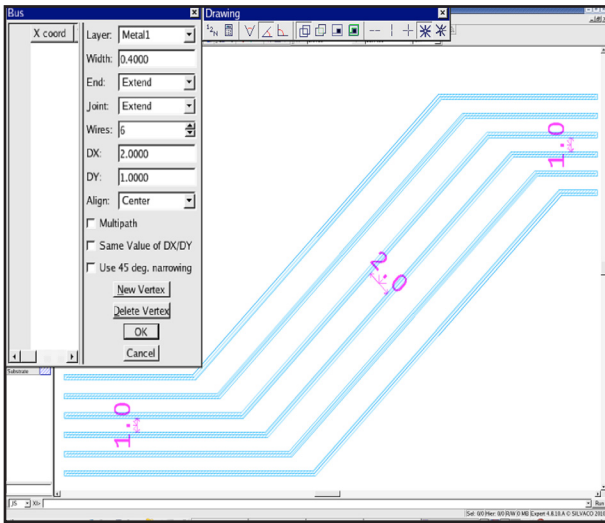

Figure 6. Angle mode=45° mode, DX≠DY.

Figure 7 and Figure 8 show that the narrow DX value is used for the W value when “45 deg. narrowing” is used.

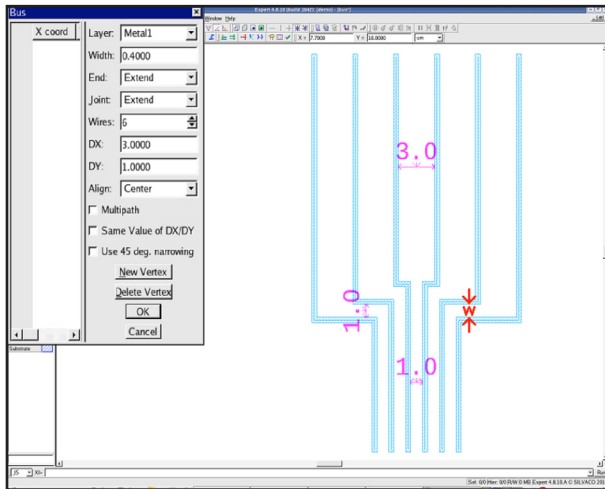

Figure 7. The DX value was changed from 1.0 to 3.0.

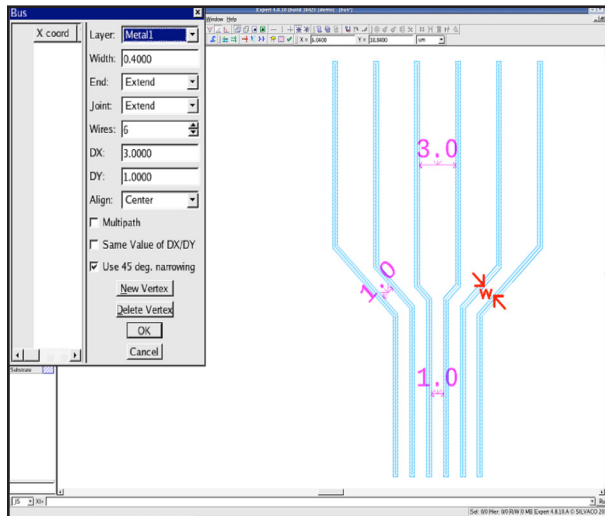

Figure 8. The DX value was changed from 1.0 to 3.0 with Use 45 deg. narrowing.

The Bus wiring can be made by changing the wiring layer when Multipath is selected.

In order to use multipath, you need contacts to be defined by [setup]->[Technology]->[Contact Setup].

To change the wiring layer, switch the active layer by either of the following methods.

- 1) Select a different wiring layer in the layer of the Numeric Input panel of the Bus command.
- 2) Select a different wiring layer on the layer bar.
- 3) Select a different wiring layer in the context menu (see Figure 9).

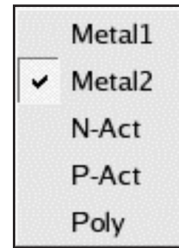

Figure 9. Layer context menu.

The Bus wiring when Multipath is turned on, and the wiring layer is changed on the way, is shown in Figure 10.

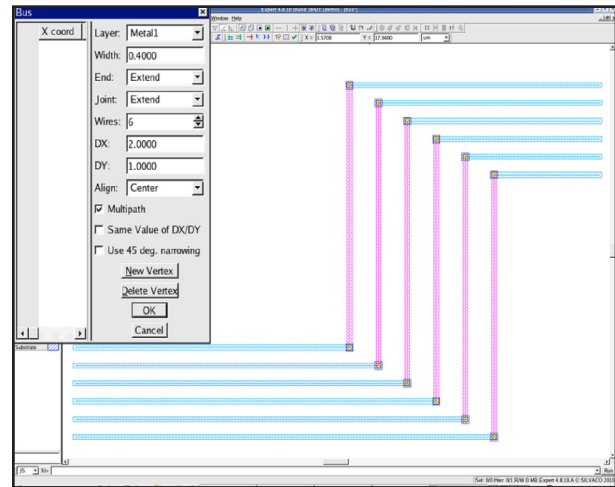

Figure 10. The wiring layer was changed on the way with Multipath.

5. Change the Bus wiring layer

The layer of a bus wiring segment can be changed as follows:

- 1) Select Edit > Stitch Wires
- 2) Click and drag a box to select the segment to be changed (see Figure 11), or use Shift+click to select individual wires
- 3) Right mouse click to pop up a context menu and select another layer (see Figure 9), or use the Input Panel of the Stitch Wires command (see Figure 12).

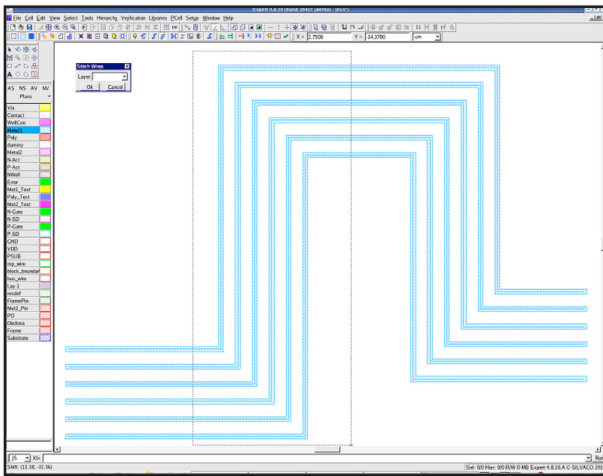

Figure 11. The selection box by Stitch Wires command.



Figure 12. The Numeric Input panel of Stitch Wires command.

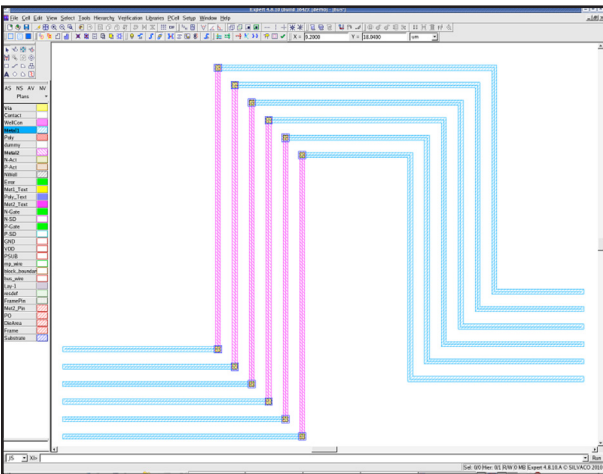

Figure 13. The bus segment changed by Stitch Wires command.

Figure 13 shows a bus segment changed by the Stitch Wires command.

6. Conclusion

The command concerning bus wiring is a standard function of Expert. A lot of bus wiring work is needed in the design of layouts such as Flat Panel Displays. If the bus wiring function is used, time-consuming bus wiring work can be achieved in a short time. In addition, the bus wiring function can be enhanced using the customizing functions in Expert such as JavaScript and LISA.